



Xorel Artform[®]
Acoustical Panels

Carnegie

Xorel Artform[®]

Xorel Artform is a versatile acoustical panel system that combines the beauty and performance of Xorel textiles with proven sound absorbing capabilities to transform interior wall and ceiling spaces in form and function without disruption.

Since its creation in 1981, Xorel continues to set the industry standard for sustainable and high-performing interior textiles by providing a design solution that's both beautiful and versatile.

Available in more than 350 colors, patterns and textures, Xorel provides boundless opportunity for designing unique environments in hotels, healthcare, offices, schools, and beyond.

A woven polyethylene with strength at its core, Xorel achieves high durability and ease of maintenance without added coatings or finishes. Cradle to Cradle™ Certified, lab tested, and proven for over 35 years with installations around the globe, Xorel is the safest, most environmentally responsible textile on the market.

In 2013, Carnegie introduced a plant-derived version, Biobased Xorel, which achieved C2C Gold certification. Delivering the same superior performance as its namesake but with an even smaller carbon footprint, it is the world's first and only biobased high performance interior textile.



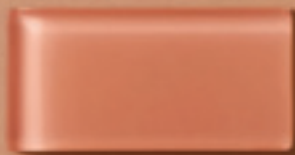

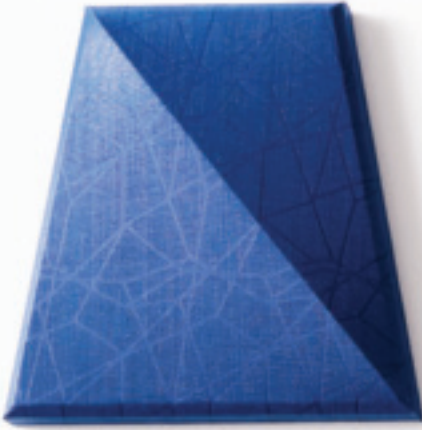

Waveline, Page 10 (3D Shown Above)



Ripple, Cover & Page 23



Tall Hex, Page 14



Hex, Page 13 (3D Shown Above)



Diamond, Page 16 (3D Shown Above)



Plank, Page 7



Scale, Page 26

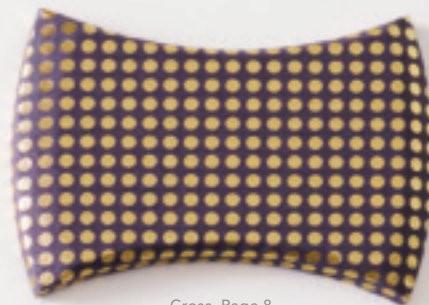

Cross, Page 8



Square, Page 7
(3D Shown Above)



Flip, Page 20 & 22



Arc, Page 9



Criss, Page 8



Circle, Page 18

Artful Possibilities

With a wide array of panel shapes, sizes, and three-dimensional options available in over 350 Xorel textile patterns, textures and colors, design opportunities with Artform are unlimited.

Achieve flexibility of expression by varying the colors and patterns of Xorel woven textiles. Fully customized and signature designs are achievable with standard product, without ever replicating the same look twice.

Added Dimension

Three-dimensional panels, available in five shapes, can be used on their own or in concert with other Xorel Artform panels to add an enhanced sculptural element to any installation.

Dimension and structural variety also can be achieved by mixing panels of different substrates within the same composition.

A Sound Decision

Addressing acoustics in open areas remains a constant challenge when designing interior spaces. Xorel Artform finished panels provide an effective solution for sound absorption and echo reduction while granting creative design opportunities limited only by the imagination.



Square 3D in size Small, Large
Plank in size Small, Large
Fabric on panels: Meteor 6427 colors 754, 722, and 725
Wall Mounted Installation, Page 33

Square / Plank
Wall Mounted

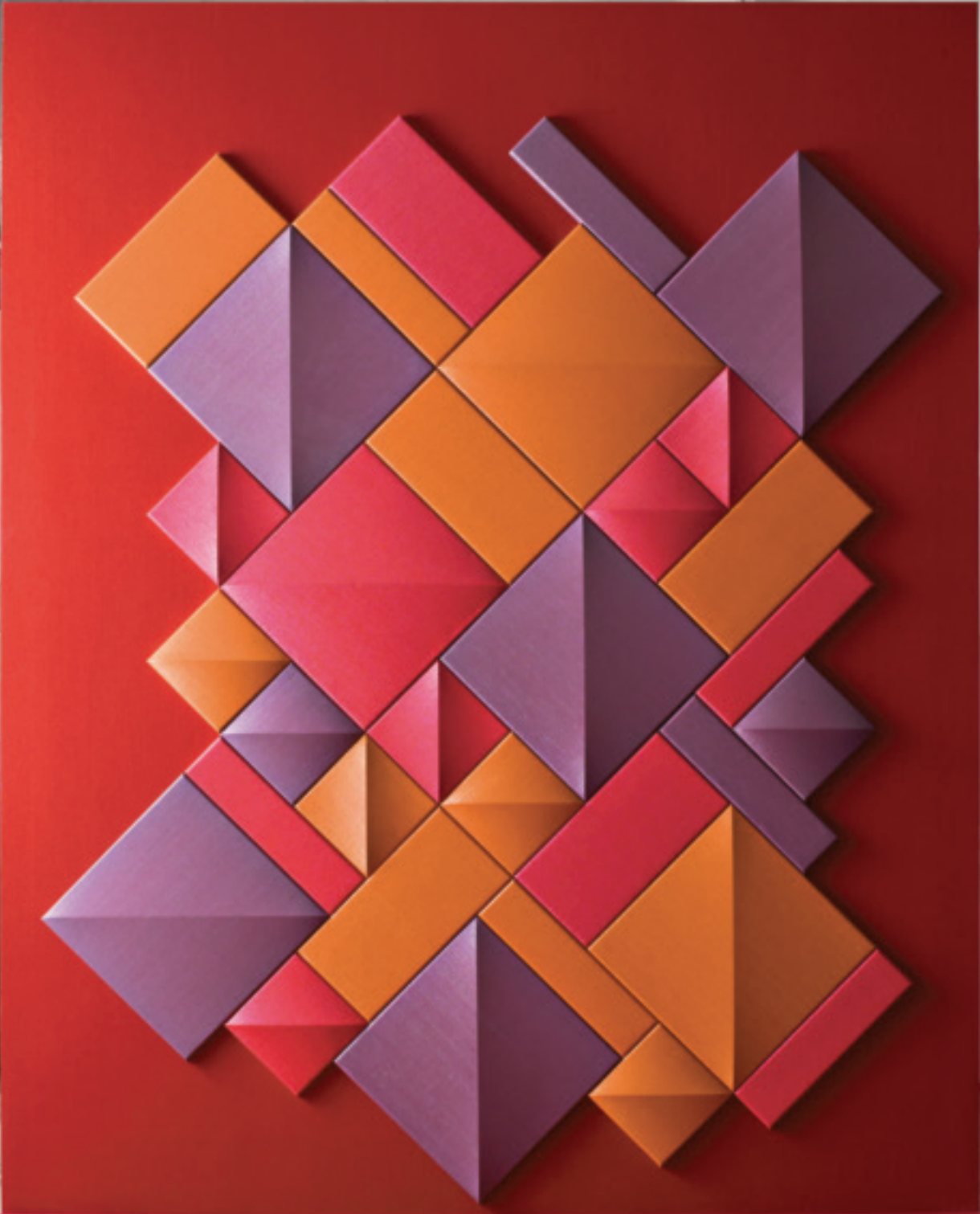

Criss / Cross
Wall Mounted



Criss in size Small, Cross in size Small
Fabrics on panels: Brigitte Couture 6289 color 803; Meteor 6427 color 757;
Pipeline 6207 color 60; Strie 6423 colors 802, and 804
Fabric on wall: Meteor 6427 color 752
Wall Mounted Installation, Page 33

Wall Mounted Panels

Wall Mounted panels combine to create a highly-crafted, elegant surface appearance that enhances any type of interior while optimizing sound performance. Versatility in application is easily achieved with small or large wall installations because Xorel Artform is uninhibited by clips or track systems.



Waveline
Wall Mounted





Waveline in size Small
Fabric on Panels: Meteor 6427 colors 722, 721, and 705;
Strie 6423 color 811
Furniture by HighTower
Wall Mounted Installation, Page 33

Crafted with beveled edges and clean, contoured corners for superior fit and finish, panels gracefully interlock to make a high impact design statement. By simply rotating dimensional panels, design connection points are altered – changing the highlights and shadows of the shapes to create new composition possibilities.



Hex in size Small
Hex 3D in size Small
Fabric on panels: Strie 6423 color 813;
Meteor 6427 colors 769, and 770
Wall Mounted Installation, Page 33

Hex
Wall Mounted



Tall Hex
Ceiling Mounted



Ceiling Mounted and Suspended Panels

Address acoustics from above while making a design statement using ceiling mounted panel groupings and horizontally suspended panels. Inspired designs can be extended from the wall onto the ceiling using flush-mounted panels, while suspended panels can be applied individually for freeform compositions or in tiled groupings to highlight artful patterns.

Tall Hex in size medium
Fabrics on panels: Haze 6041 14;
Trace 6039 4; Twine 6217 33
Ceiling Mounted Installation, Page 34

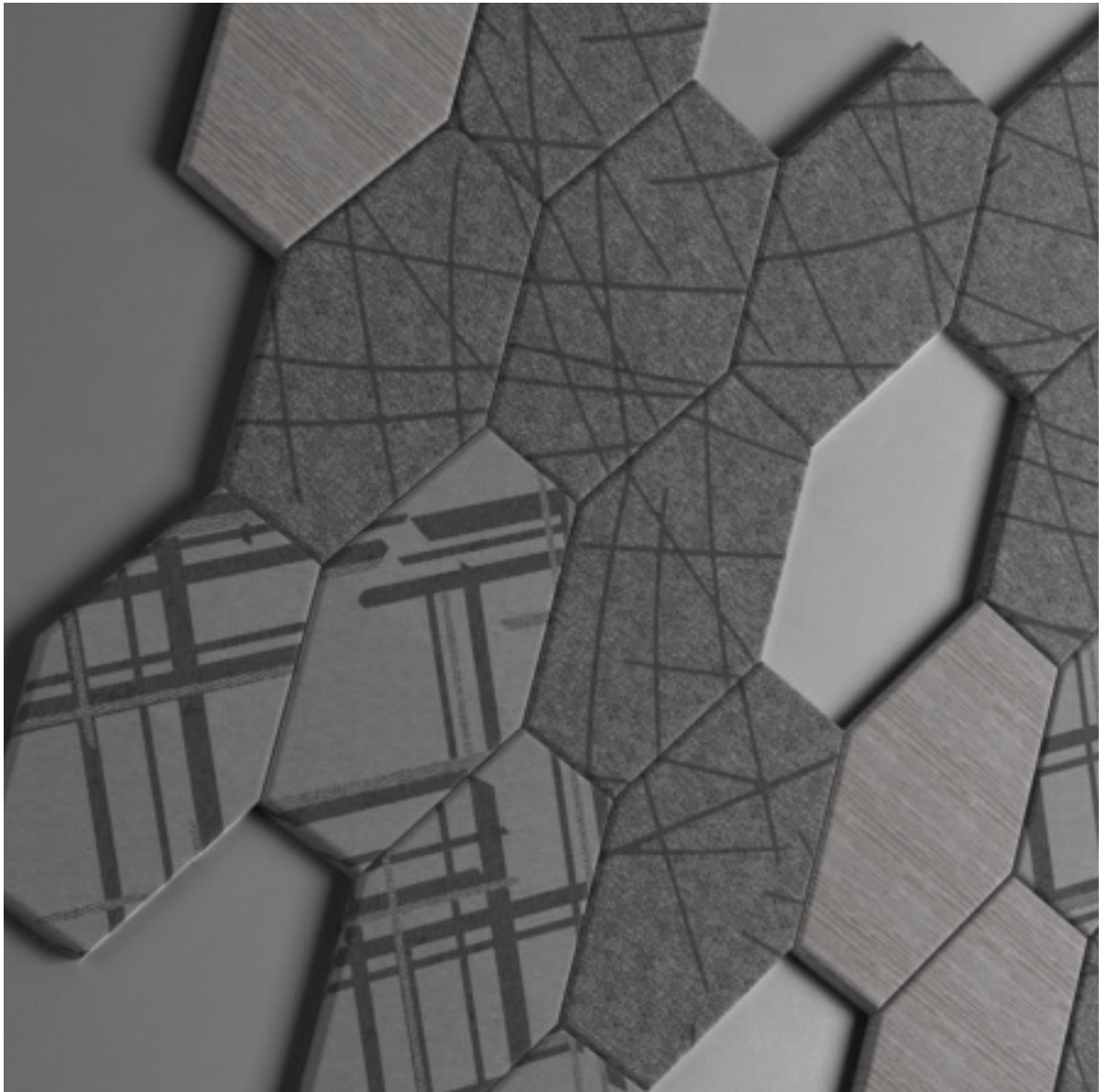

Diamond
Ceiling Horizontally Suspended—Tiled

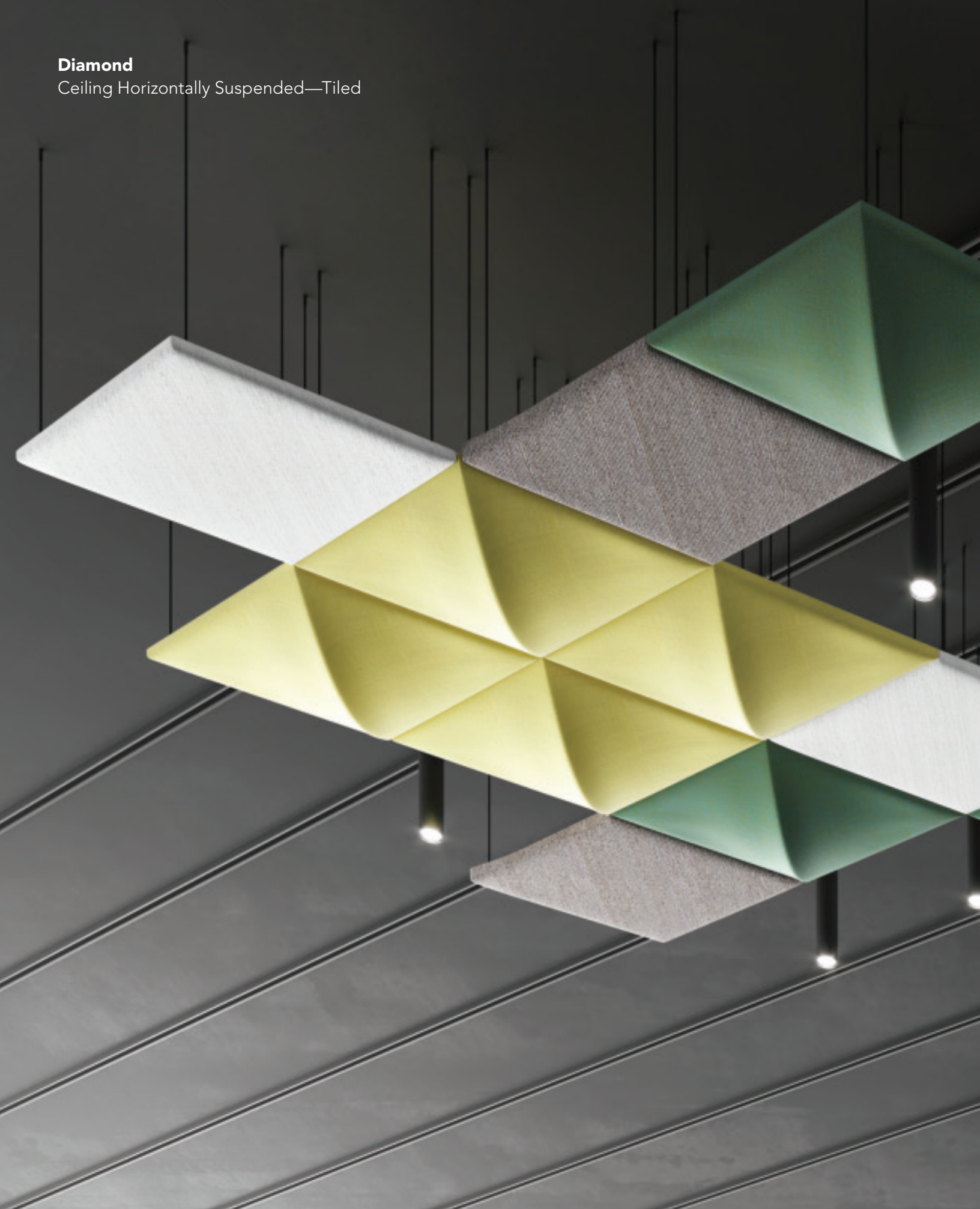



Diamond in size large
Diamond 3D in size large
Fabric on panels: Meteor 6427 730, 738;
Nexus 6425 902; Tangle 6213 11
Ceiling Horizontal Suspension Installation—Tiled, Page 34

Circle
Ceiling Horizontally Suspended—Individual



A woman with long dark hair, wearing a grey sweater, is shown in profile from the chest up. She is holding a stack of architectural blueprints in her left hand and a tablet computer in her right hand. The blueprints show a detailed floor plan of a building. In the background, there is a wooden table with a blue chair and a laptop, suggesting a professional or creative workspace. The overall lighting is soft and even.

Xorel Artform[®]
Design Ally[®]



When time is of the essence and creativity can't be compromised, lean on us. Offered as a complimentary service, the Xorel Artform Design Ally® team can generate prompt design layouts and make pattern/color suggestions based on your design narrative.

No matter the environment—from hospitality to healthcare, from offices to educational spaces and beyond—Design Ally can supply you with unique shape configurations inspired by your color palette and design vision.

Renderings and budget projections also are provided to support your specific project requirements.

Contact a Carnegie Salesperson, email info@xorelartform.com or visit xorelartform.com/design/ally



Design Ally® Process

01. Design Engagement

What are the wall dimensions? Design inspiration? Preference on Artform shapes and sizes? Budget parameters?

02. Design Ally Creative

Renderings are shared, ensuring design concepts achieve your vision.

03. Project Order

Detailed product order specifications are provided for easy ordering.

04. Installation

The Design Ally team can direct you to our Preferred Installer Network to achieve superior installation results.

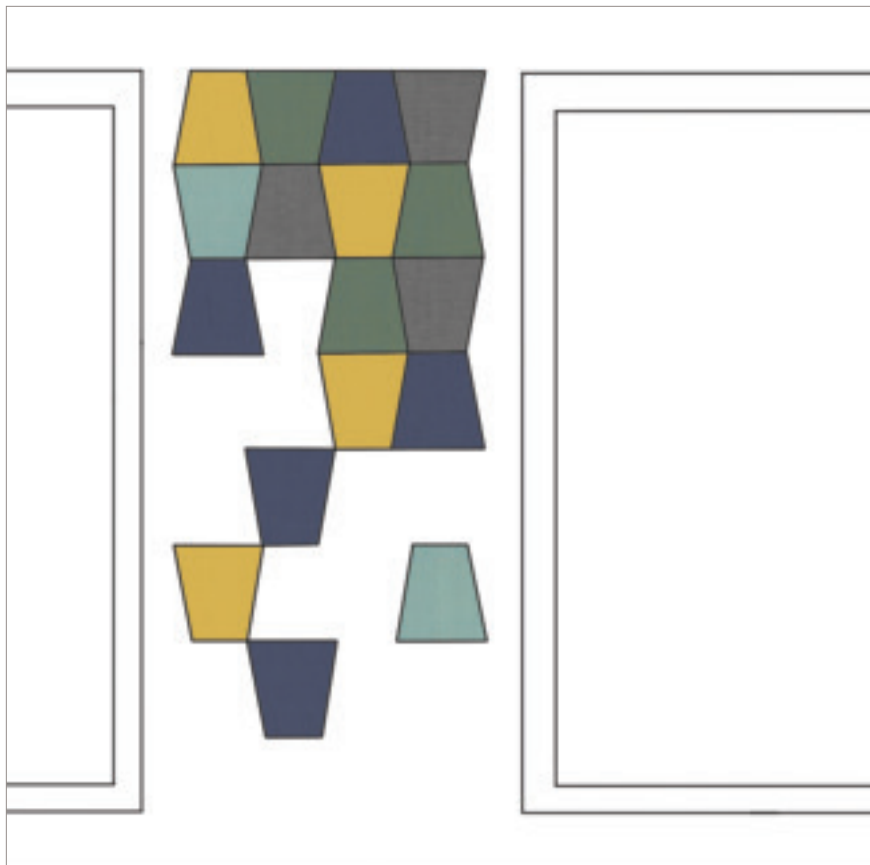

View case study at xorelartform.com/case-studies/university-of-virginia



Project No.
AF000065

Project Name:
UVA Language Lab

Shape:
Waveline (small)

Total Panels:
34

Total Boxes:
7

Material + Quantity

Meteor 6427-720



2 Boxes / 8 Panels

Meteor 6427-738



1 Box / 6 Panels

Meteor 6427-768

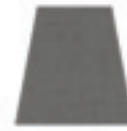

1 Box / 6 Panels

Meteor 6427-751



2 Boxes / 10 Panels

Flash Back 6615-52



1 Box / 4 Panels

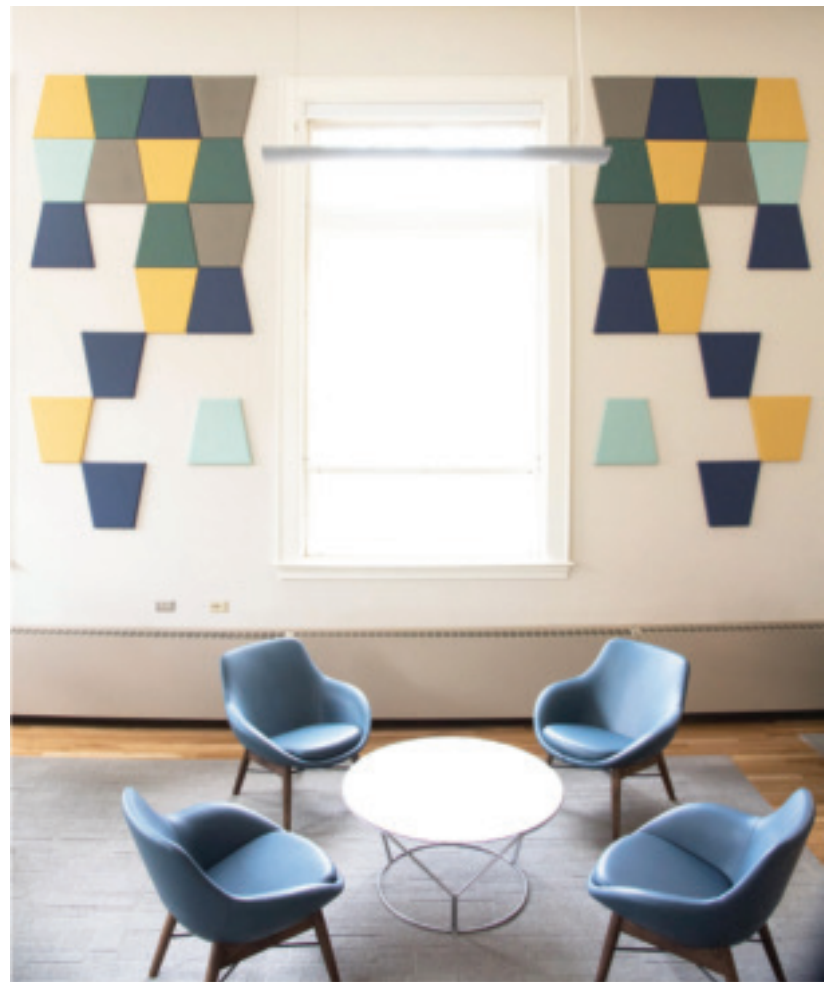
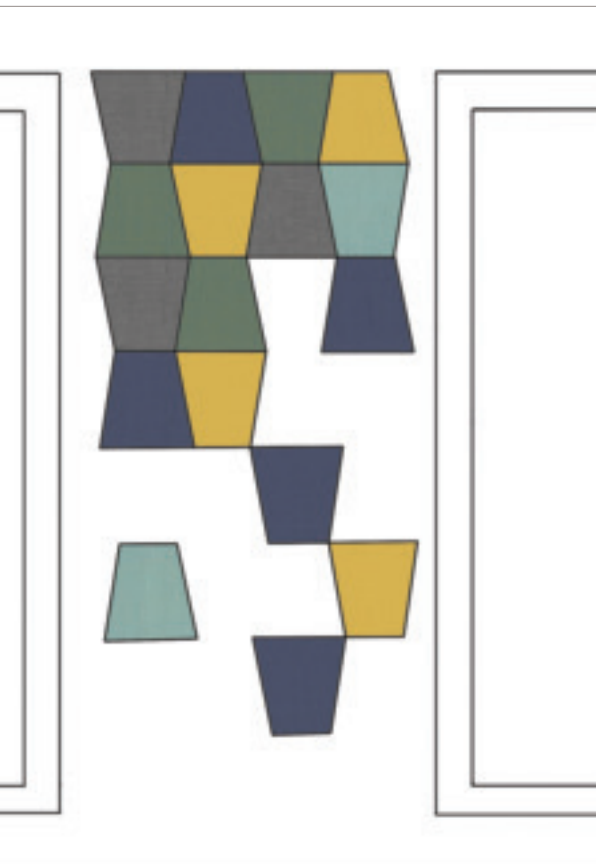

Instant Artform

For added inspiration and to ease the pressure of design time constraints, designers can draw from Instant Artform, an on-line library of ready to order layout options developed and curated by the Carnegie Creative Studio.

Using a wide variety of Artform panel shapes, sizes and color palettes, design options are available in various sizes.

Instant Artform is accessed through a highly intuitive interface on Xorelartform.com that allows a designer to save time and explore options based on parameters such as budget. Design layouts can be viewed and downloaded along with specifications, installation instructions and total product costs.



Features:

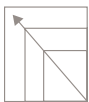

Various Wall Size Options

Each design option is offered in layouts for 3 typical size areas types: phone booth (small), conference wall (medium) and open office walls (large).



Pricing of Solutions

Total product costs can be downloaded for each design option. Designers can search options based on budget.

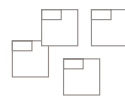

Material Selections

High Performance Xorel textiles are offered in more than 350 colorways on 15 distinctive shapes for endless design opportunities.



Further Customization

Instant Artform provides designed options with sized layouts and color palettes that can provide inspiration for your own customized designs.

View all Instant Artform layouts online at xorelartform.com/instant-artform

Pricing Models

Density

Cost is relative to area covered

FULL

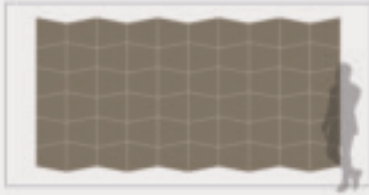

16' x 8' Wall Area (128 SQ FT)
Full Density Coverage

Quiet-Core™

Total Panels: 70
Total Boxes: 12
Total Price: \$9,648
SQ FT Cost: \$75

Mi-Core™

Total Panels: 70
Total Boxes: 12
Total Price: \$8,220
SQ FT Cost: \$64

MEDIUM



16' x 8' Wall Area (128 SQ FT)
Medium Density Coverage

Quiet-Core™

Total Panels: 55
Total Boxes: 10
Total Price: \$8,040
SQ FT Cost: \$63

Mi-Core™

Total Panels: 55
Total Boxes: 10
Total Price: \$6,850
SQ FT Cost: \$54

LOW



16' x 8' Wall Area (128 SQ FT)
Low Density Coverage

Quiet-Core™

Total Panels: 38
Total Boxes: 7
Total Price: \$5,628
SQ FT Cost: \$44

Mi-Core™

Total Panels: 38
Total Boxes: 7
Total Price: \$4,795
SQ FT Cost: \$37

Scale

Shape size affects coverage and cost

SMALL

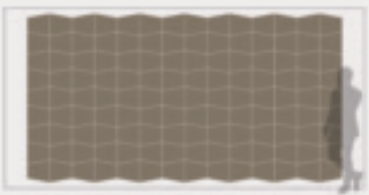

16' x 8' Wall Area (128 SQ FT)
Full Density Coverage

Quiet-Core™

Total Panels: 126
Total Boxes: 21
Total Price: \$13,335
SQ FT Cost: \$104

Mi-Core™

Total Panels: 126
Total Boxes: 21
Total Price: \$10,395
SQ FT Cost: \$81

MEDIUM

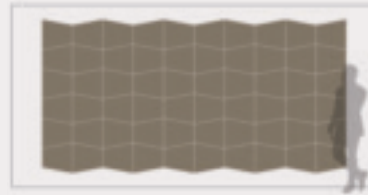

16' x 8' Wall Area (128 SQ FT)
Full Density Coverage

Quiet-Core™

Total Panels: 70
Total Boxes: 12
Total Price: \$9,648
SQ FT Cost: \$75

Mi-Core™

Total Panels: 70
Total Boxes: 12
Total Price: \$8,220
SQ FT Cost: \$64

LARGE

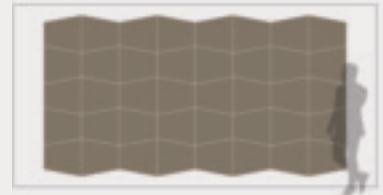

16' x 8' Wall Area (128 SQ FT)
Full Density Coverage

Quiet-Core™

Total Panels: 40
Total Boxes: 7
Total Price: \$8,939
SQ FT Cost: \$70

Mi-Core™

Total Panels: 40
Total Boxes: 7
Total Price: \$7,406
SQ FT Cost: \$58

Costs shown are for estimates only



Contact Us

Design Ally Services
xorelartform.com/design/ally

Email
info@xorelartform.com

Phone
1-800-727-6770

Find Your Rep
carnegiefabrics.com/us-sales

Locations
United States & Canada

All Xorel fabrics are C2C Certified.
Visit xorelartform.com for more information.

© 2019 Carnegie Fabrics, Inc. Printed on recycled paper.
Xorel is a registered trademark of Carnegie Fabrics Inc.
Xorel registered trademark and license to distribute is granted by permission of Carnegie Fabrics Inc. USA

Circle shapes allow for fluid, unlinked compositions that create endless acoustic design possibilities. Design with single circle size sets or create a riot of pattern and color with a Circle Kit variety pack that features a box set of 6 circle shapes in multiple sizes.



Circle in size 2Xlarge
Fabric on panel: Kaleidoscope 6253 8
Ceiling Horizontal Suspension Installation—Individual, Page 34

Ceiling Vertically Suspended Baffles

The newest addition to the Xorel Artform family, baffles are high-performance, acoustic panels that enable distinctive design statements to be made from above. Instead of being limited to a monolithic material or simply a graphic color story, Xorel Artform two-sided upholstered baffles can deliver texture, bold patterns and hundreds of color options offering design versatility for your every project.

Xorel Artform Baffles deliver excellent acoustical performance with a noise reduction coefficient (NRC) rating of 1.5.



Flip Baffle in size large
Fabrics on baffles: Arrow 6031 5
Dash 6603 28
Meteor 6427 714, 719, 726, 731, 739
Sleet Embroider 6299 809
Ceiling Vertically Suspended Baffles Using Cables, Page 35

Flip

Ceiling Vertically Suspended Baffles



New Artform shapes, Flip and Ripple offer a striking array of installation and aesthetic possibilities. As a baffle, Ripple's undulating shape works well individually or combined in a series for more dramatic effect. It also works beautifully in a wall panel application, delivering seamless design impact from wall to ceiling. Flip baffles allow for a different color to be specified on each side to create contrast and visual interest.

Flip

Ceiling Vertically Suspended Baffles



Flip Baffle in size large
Fabrics on panels: Meteor 6427 720, 722
Ceiling Vertically Suspended Baffles Using Rods, Page 35

Ripple
Ceiling Vertically Suspended Baffles

Ripple Kit
Fabrics on panels: Flux 6557 91; Meteor 6427 705,
713, 766; Strie 6423 818, 825
Ceiling Vertically Suspended Baffles
Using Cables, Page 35



Expanding the Possibilities with Carnegie Textiles

In addition to high-performance Xorel textiles, Artform acoustical and tackable panels now also can be specified in 7 Carnegie fabric lines that range in sheen, texture and vibrancy to create even more design opportunities. From soft felts to plush velvets, from warm neutrals to bright, saturated hues, a playful or luxe look can easily be achieved with this expanded textile offering.

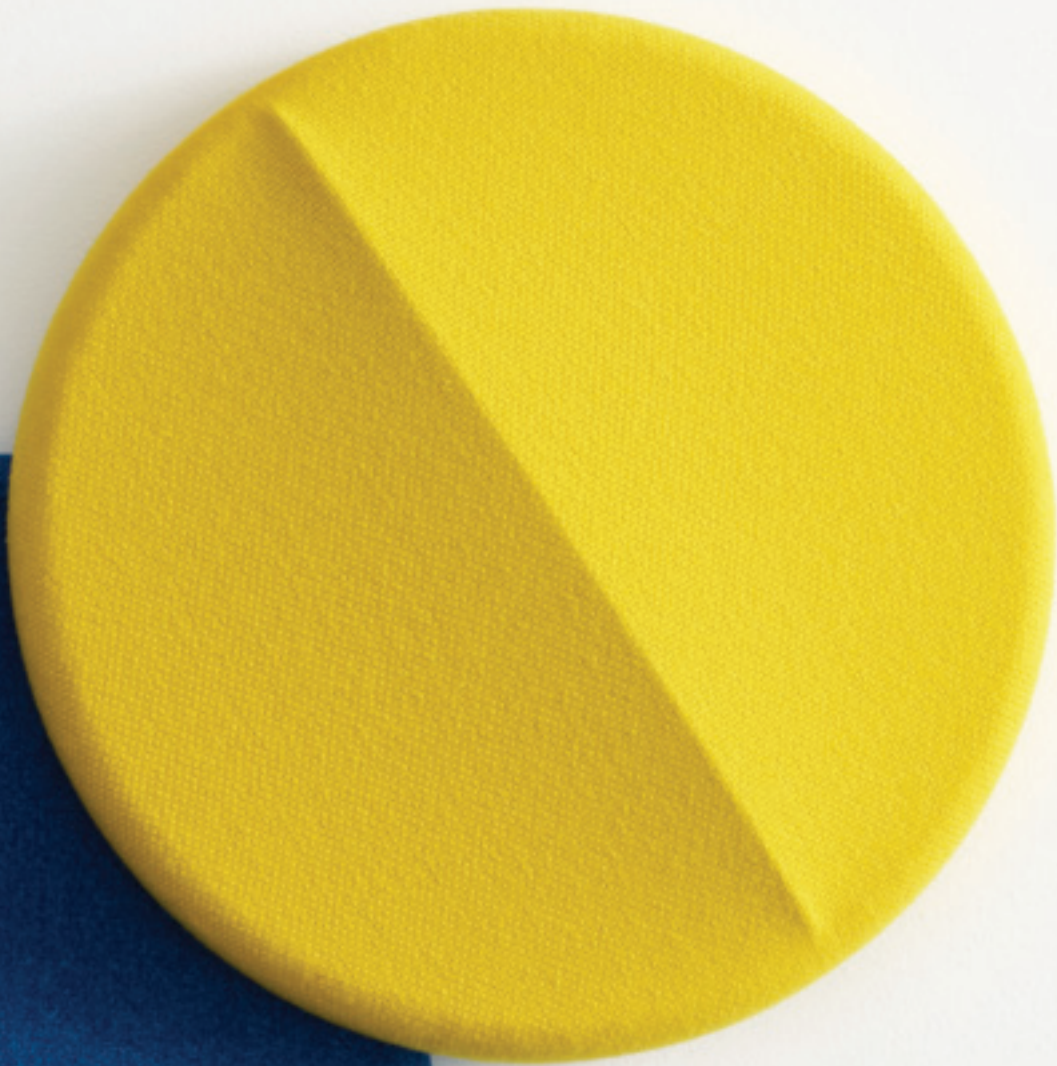

Specifying Artform

Addressing acoustics in open areas remains a constant challenge when designing interior spaces. Xorel Artform finished panels and baffles provide an effective solution for sound absorption and echo reduction while granting creative design opportunities limited only by the imagination. We offer three substrates; Quiet-Core™, Quiet-Core Plus™ and Mi-Core™.

Noise Reduction Coefficient (NRC) is the measure of a material's ability to absorb sound within the frequency range of speech. An NRC of 0 will reflect all sound that hits it. A material with an NRC of 1.0 will theoretically absorb all sound that hits it. Quiet-Core has an NRC rating of 0.7 (70% of sound is absorbed), and Quiet-Core Plus has an NRC of 0.8 (80% of the sound is absorbed).



The Mi-Core substrate option provides moderate acoustical properties. A combination of the Quiet-Core 1" substrate & Mi-Core ¾" substrate can achieve acoustical performance, while creating a 3-Dimensional effect.

Acoustical Performance

Quiet-Core™

This acoustical substrate is sound absorbing, formaldehyde-free and manufactured with 20% post-consumer recovered materials. It is available in a 1" thickness and used for all 3D shapes.

It meets ASTM E84 Class A/Class 1.

Not recommended as a tackable surface.

Acoustical Performance

250Hz	.25
500Hz	.84
1000Hz	1.06
2000Hz	1.03
4000Hz	.99
NRC	.80

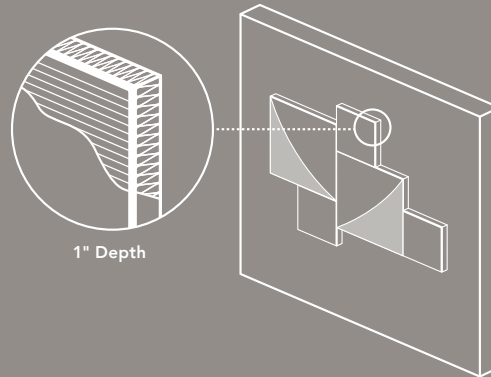

Quiet-Core Plus™

Quiet-Core Plus is a tackable and acoustical solution. Constructed with a 1/8" high density substrate of inorganic minerals & wool blend fastened to the face of the standard Quiet-Core panel. **This panel provide tackability and exceptional acoustical performance.** Also ideal for high traffic areas.

Acoustical Performance

250 Hz	.53
500 Hz	1.07
1000 Hz	.92
2000 Hz	.68
4000 Hz	.55
NRC	.80

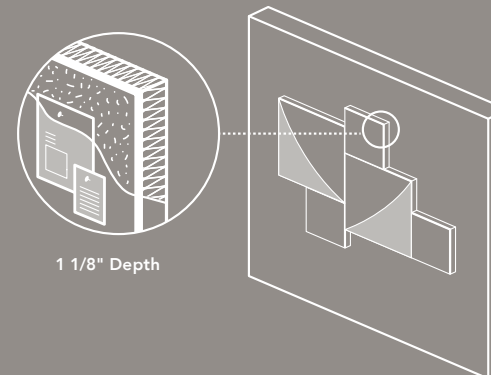

Mi-Core™

This **tackable** substrate offers moderate acoustical properties. Mi-Core is constructed with inorganic minerals and fibers making it resistant to moisture and warping. **Mi-Core is a dense material recommended for high traffic areas.** It is available in 1/2" & 3/4" thickness. It meets ASTM E84 Class A/Class 1.

3D shapes are not available in Mi-Core Substrate.

Acoustical Performance

250Hz	.18
500Hz	.31
1000Hz	.36
2000Hz	.41
4000Hz	.46
NRC	.30

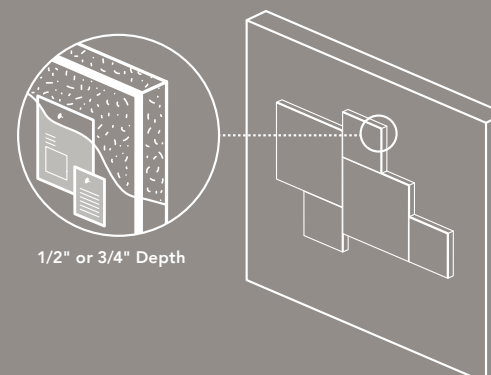

Artform Shapes

Arc

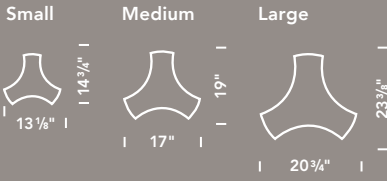

Circle / Circle 3D

Standard and 3D shapes share the same dimensions

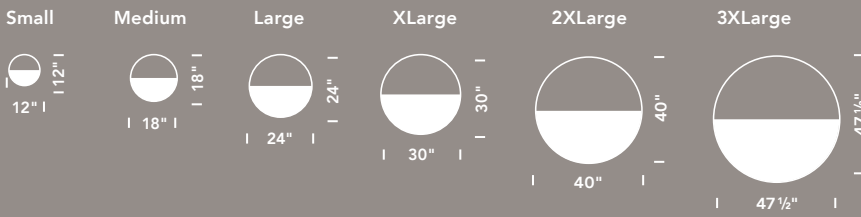

Criss

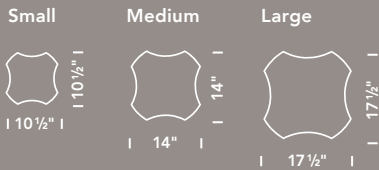

Designed to also work together. See Page 8

Cross



Diamond / Diamond 3D

Standard and 3D shapes share the same dimensions

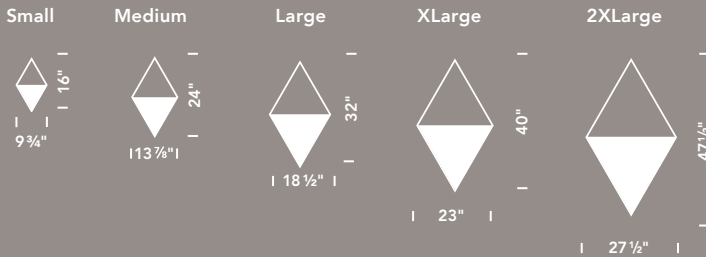

Flip

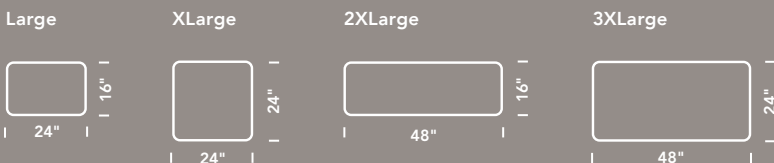

Hex / Hex 3D

Standard and 3D shapes share the same dimensions

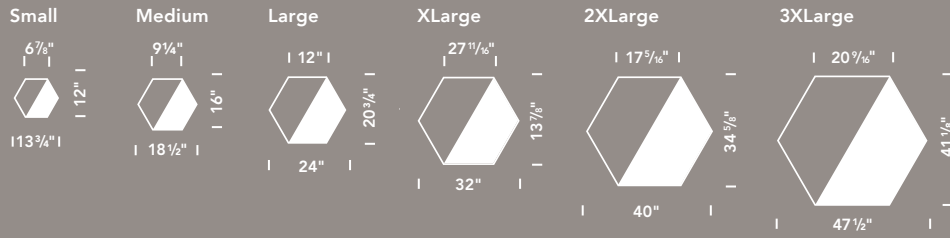

Plank

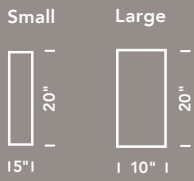

Scale

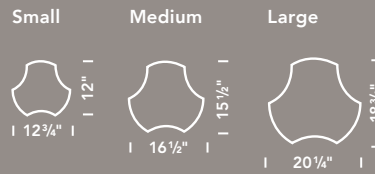

Square / Square 3D

Standard and 3D shapes share the same dimensions

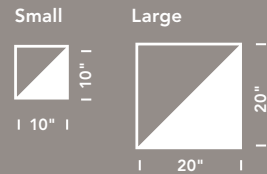

Tall Hex

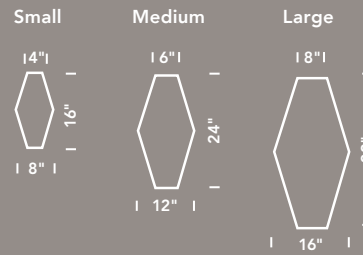

Waveline / Waveline 3D

Standard and 3D shapes share the same dimensions

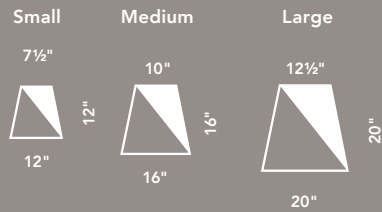

Ripple

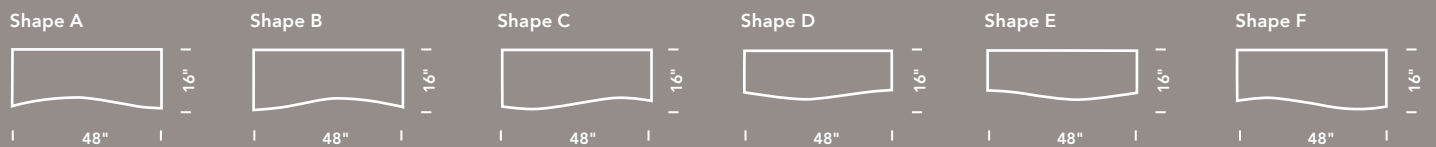

Specifications

Installation	Wall Mounted	Ceiling Mounted	Ceiling Horizontally Suspended—Tiled	Ceiling Horizontally Suspended—Individual	Ceiling Vertically Suspended Baffles
Arc					
Small	•	•			
Medium	•	•	•		
Large	•	•	•		
Circle + Circle 3D					
Small	•	•			
Medium	•	•	•	•	
Large	•	•	•	•	•
X-Large	•	•	•	•	•
2X-Large	•	•	•	•	•
3X-Large	•	•	•	•	•
Mounted Kit / 2(S), 2(M), 1(L), 1(XL)	•	•			
Horizontal Suspended Ceiling Kit / 2(M), 2(L), 1(XL), 1(2XL)	•	•	•	•	
Vertical Suspended Ceiling Kit / 2(L), 2(XL), 1(2XL), 1(3XL)					•
Criss					
Small	•	•			
Medium	•	•	•		
Large	•	•	•	•	
Cross					
Small	•	•			
Medium	•	•			
Large	•	•			
X-Large	•	•			
Diamond + Diamond 3D					
Small	•	•			
Medium	•	•	•		
Large	•	•	•	•	•
X-Large	•	•	•	•	•
2X-Large	•	•	•	•	•
Flip					
Large	•	•	•	•	•
X-Large	•	•	•	•	•
2X-Large	•	•	•	•	•
3X-Large	•	•	•	•	•
Hex + Hex 3D					
Small	•	•			
Medium	•	•	•	•	
Large	•	•	•	•	•
X-Large	•	•	•	•	•
2X-Large	•	•	•	•	•
3X-Large	•	•	•	•	•
Plank					
Small	•	•			
Large	•	•	•		
Ripple					
Kit / 1 row 6 panels	•	•			•
Square + Square 3D					
Small	•	•			
Large	•	•	•	•	
Scale					
Small	•	•			
Medium	•	•	•		
Large	•	•	•	•	
Tall Hex					
Small	•	•			
Medium	•	•	•		
Large	•	•	•	•	
Waveline + Waveline 3D					
Small	•	•			
Medium	•	•	•	•	
Large	•	•	•	•	

Box Sets

Xorel Artform is priced and sold in box sets of the same shape, size, substrate, fabric and color. Each box arrives to the job site securely packed and includes all installation and adhesive materials.

Ceiling Horizontal Suspension Individual hardware is sold separately. Fast Delivery: 2–6 week lead time.

Standard

3-6 panels/box

3D

3-4 panels/box

Baffle

3 baffles/box

Minimum order is 1 box.

Dimensional Orientation

Box sets of Hex, Waveline, and Square 3D panels include “handed” shapes which feature the dimensional element oriented towards either right or left. This attention to detail ensures that the specified Xorel fabric weave is wrapped along the panel in the same direction so that fit and finish are not compromised when changing panel orientation. Two of each handed shape are included in each box set.





Installing Artform

Versatility and simplicity are fundamental to Xorel Artform's variety of installation methods. Great care and attention have been dedicated to ensuring that product installation is straightforward, time efficient and even mobile. Wall and ceiling hardware are easy to use and are designed to recede into the background, making the Artform panels—and your design—the focal point of the space.



Wall Mounted Installation

Fast and easy to install with little disruption or major clean up, Xorel Artform is the optimal solution to address post-occupancy acoustical issues. Panels are lightweight and install simply with a Quick Grab adhesive, 3M Command™ strips or Velcro® fasteners, eliminating the high labor costs associated with rail and hardware systems



To ensure complete customer satisfaction and achieve superior installation results, a Preferred Installer Network of vetted and trained professionals expert in the capabilities, ordering and installation practice of Xorel Artform is available as an added service.

Flush Mounting Options

Quick Grab

Quick Grab adhesive is a VOC-compliant construction adhesive with very low odor for little to no off-gassing. It fits standard caulk guns for easy installation.

Quick Grab Concrete

Xorel Artform can be installed on flat and smooth concrete surfaces with Quick Grab Concrete. Use on highly textured surfaces could potentially result in uneven installation.

Velcro® Fasteners

Velcro fasteners are also offered as a flexible mounting option.

3M Command™ Strips

Command Strip install method enables the product to be mounted securely and then removed with no damage to the panels or painted wall. Panels then can be boxed and transported to the next location and mounted again; even in a new configuration.

Ceiling Mounted Installation

The ability to horizontally hang panels or panel groupings to reduce reflected sound opens up the opportunities for creative acoustical solutions overhead. Xorel Artform acoustic Quiet-Core™ panels are lightweight and can be flush-mounted onto sheetrock and concrete ceilings or suspended. Suspension mounting in tiled configurations or single panels is simple when ordered with our ready-to-fasten hardware system.



Ceiling Horizontal Suspension for Individual Panels

Flush Mounting Options

Quick Grab

Quick Grab adhesive is a VOC-compliant construction adhesive with very low odor for little to no off-gassing. It fits standard caulk guns for easy installation.

Quick Grab Concrete

Xorel Artform can be installed on flat and smooth concrete surfaces with Quick Grab Concrete. Use on highly textured surfaces could potentially result in uneven installation.

Horizontal Suspension Options

Ceiling Horizontally Suspended—Tiled (pg 16)

Xorel Artform panels are manufactured with ready-to-fasten hardware. Hanging rods and joiner strips for tiling are included in each box set.

Not available in Small size shapes. Not applicable for Cross panel shape. Must tile in groups of three or more.

Ceiling Horizontally Suspended—Individual (pg 18)

Xorel Artform panels are manufactured with ready-to-fasten hardware for individual suspension mounting. Installation materials, including plate and rod hardware, is sold separately.

Available in select shapes and sizes: Circle/Circle 3D/Hex/Hex 3D in sizes M/L/XL/2XL/3XL, Criss/Scale/Square/Square 3D/Tall Hex in size L, Diamond/Diamond 3D in sizes L/XL/2XL, Waveline/Waveline 3D in sizes M/L.

Ceiling plate hardware is paintable, Krylon dual paint-primer spray is recommended. Rod hardware must be primed prior to painting.

Vertically Suspended Baffle Installation

Vertically suspended ceiling baffles not only open up design possibilities but also allow for sound absorption on both sides for increased sound clarity. Especially suited for large spaces or areas with limited wall space, baffles can be vertically suspended using hanging rods or cables on all ceilings, including drop ceilings.



Ceiling Vertically Suspended Baffles Using Cables

Suspension Mounting Options

Ceiling Vertically Suspended Baffles Using Cables (pgs 20, 21, 23)

Xorel Artform baffles are manufactured with ready-to-fasten hardware for ceiling suspension. Installation materials, including cables and pendants, for vertically suspended baffles are included in each box set.

Ceiling Vertically Suspended Baffles Using Rods (pg 22)

Xorel Artform baffles are manufactured with ready-to-fasten hardware for ceiling suspension. Installation materials, including hanging rods, for vertically suspended baffles are included in each box set.



Drop Ceiling Vertically Suspended Baffles Using Cables

Drop Ceiling Vertically Suspended Baffles Using Cables

Xorel Artform baffles are manufactured with ready-to-fasten hardware for drop ceiling suspension. Installation materials, including cables and T-bar clips, for drop ceiling suspension are included in each box set.

Drop Ceiling Vertically Suspended Baffles Using Rods

Xorel Artform baffles are manufactured with ready-to-fasten hardware for drop ceiling suspension. Installation materials, including T-bar clips and rod hardware, for drop ceiling suspension are included in each box set.

Why Xorel Artform

Leverages the high performance of Xorel textiles

- Durable and colorfast
- Antibacterial
- Easy to clean / bleach cleanable
- Free of chemical finishes
- 3rd Party Certified for sustainability
- Lab tested
- Over 350 colors, patterns and textures

Varying shapes and sizes to create limitless design possibilities

Acoustical and tackable properties

Simple installation with minimal labor costs

Design Ally - complimentary design support service

5-year Warranty

Fast Delivery: 2-6 week lead time

